



Winstar Display Co., LTD

華凌光電股份有限公司



住址: 407 台中市清路 163 號
No.163 Chung Ching RD.,
Taichune, Taiwan, R.O.C

WEB: <http://www.winstar.com.tw>
E-mail: sales@winstar.com.tw
Tel:886-4-24262208 Fax : 886-4-24262207

SPECIFICATION

CUSTOMER : _____

MODULE NO.: WF35DTIBCDE#

<p align="center">APPROVED BY:</p> <p>(FOR CUSTOMER USE ONLY)</p>	<p>PCB VERSION: _____</p> <p>DATA: _____</p>
--	--

SALES BY	APPROVED BY	CHECKED BY	PREPARED BY

VERSION	DATE	REVISED PAGE NO.	SUMMARY
0	2009.05.12		First issue



RECORDS OF REVISION

DOC. FIRST ISSUE

VERSION	DATE	REVISED PAGE NO.	SUMMARY
0	2009.05.12		First issue

Contents

- 1. Module Classification Information**
- 2. Block Diagram**
- 3. Electrical Characteristics**
- 4. Absolute Maximum Ratings**
- 5. Interface Pin Function**
- 6. DC Characteristics**
- 7. AC Characteristics**
- 8. Data transfer order Settin**
- 9. Register Depiction**
- 10. Optical Characteristics**
- 11. Contour Drawing**
- 12. Reliability**
- 13. Cosmetic Criteria of LCD Screen**

1. Module Classification Information

W F 35 D T I B C D E #
① ② ③ ④ ⑤ ⑥ ⑦ ⑧ ⑨ ⑩ ⑪

- ① Brand : WINSTAR DISPLAY CORPORATION
- ② Display Type : H→Character Type, G→Graphic Type F→TFT Type
- ③ Display Size : 3.5" TFT
- ④ Model serials no.
- ⑤ Backlight Type : F→CCFL, White T→LED, White

- ⑥ LCD Polarize A→Reflective, N.T, 6:00 H→Transflective, W.T,6:00
Type/ Temperature D→Reflective, N.T, 12:00 K→Transflective, W.T,12:00
range/ View G→Reflective, W. T, 6:00 C→Transmissive, N.T,6:00
direction J→Reflective, W. T, 12:00 F→Transmissive, N.T,12:00
 B→Transflective, N.T,6:00 I→Transmissive, W. T, 6:00
 E→Transflective, N.T.12:00 L→Transmissive, W.T,12:00
- ⑦ A: TFT LCD
B: TFT+FR+CONTROL BOARD
C: TFT+FR+A/D BOARD
D:TFT+FR+A/D BOARD+CONTROL BOARD
- ⑧ Solution: A: 128160 B:320234 C:320240 D:480234
- ⑨ D: Digital A: Analog
- ⑩ Version
- ⑪ Special Code #:Fit in with ROHS directive regulations

This product is composed of a TFT LCD panel, driver ICs, FPC, Control Board and a backlight unit. The following table described the features of WF35DTIBCDE#

Item	Dimension	Unit
Dot Matrix	320 x RGBx240(TFT)	dots
Module dimension	93.5 x 66.44 x 7.96	mm
View area	73.1x55.6	mm
Active area	70.08 x 52.56	mm
Dot size	0.073 x 0.219	mm
Driving IC package	COG	
LCD type	TFT, Negative, Transmissive	
View direction	6 o'clock	
Backlight Type	LED,Normally White	
Driver IC	Himax: HX8238-A or equivalent	

*Expose the IC number blaze (Luminosity over than 1 cd) when using the LCM may cause IC operating failure.

*Color tone slight changed by temperature and driving voltage.

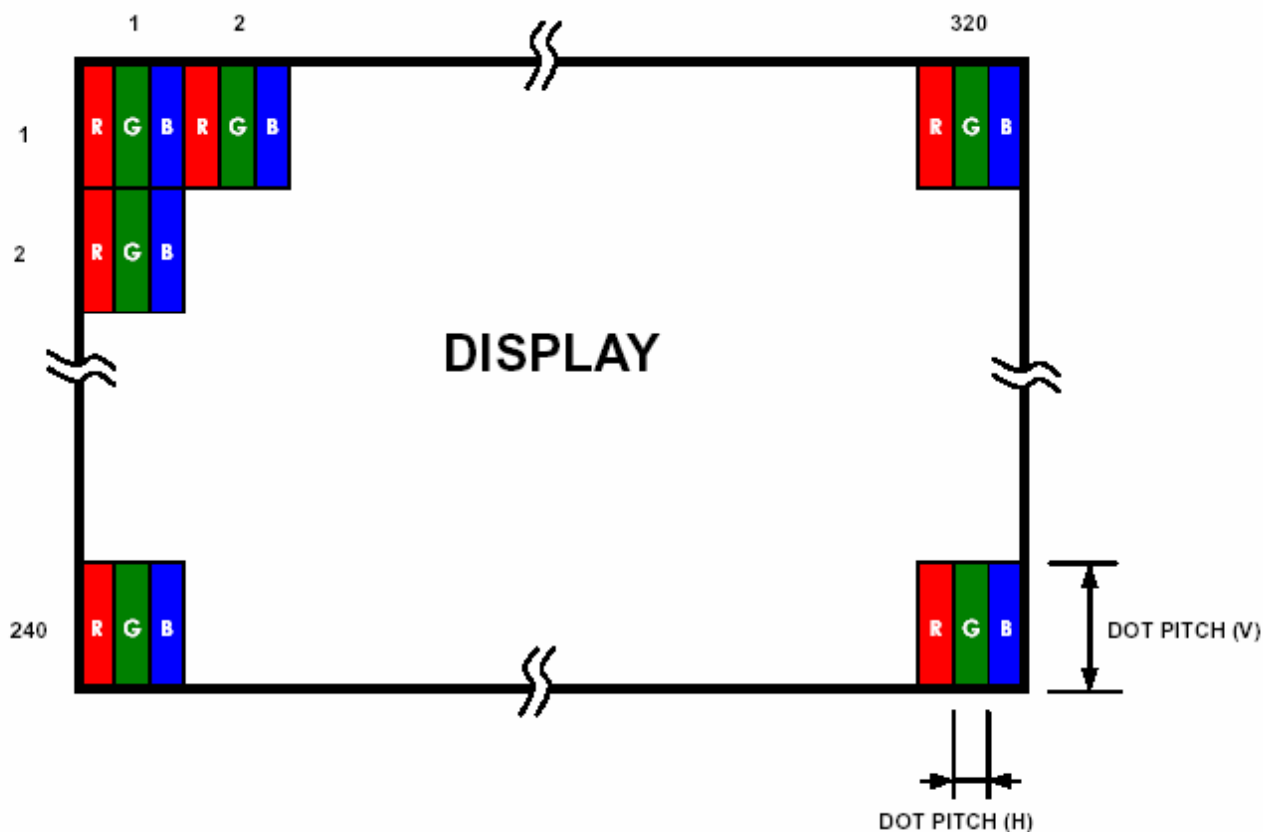

2. Block Diagram

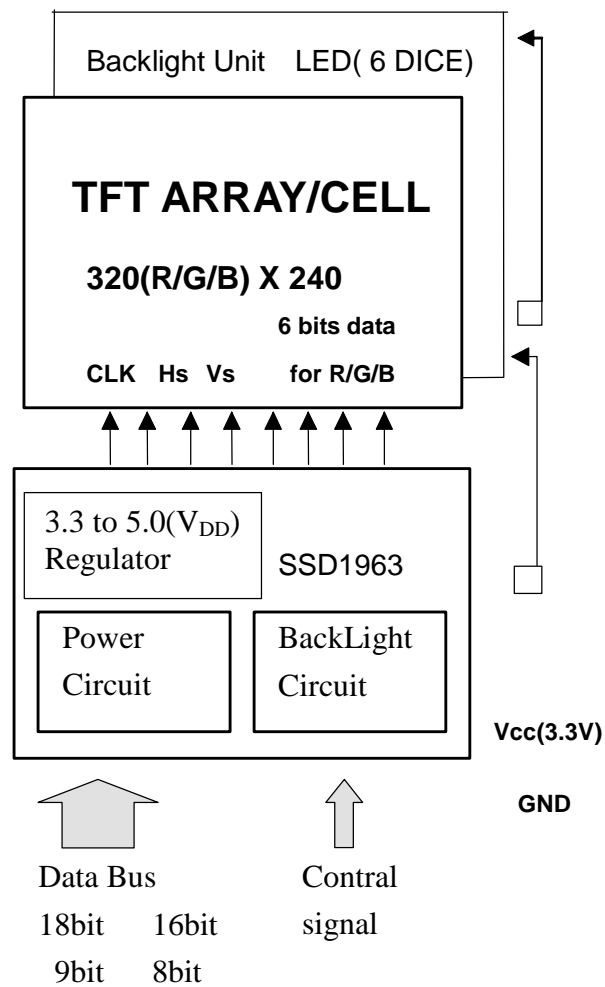

3. Electrical Characteristics

3.1 Operating conditions:

Item	Symbol	Condition	Min	Typ	Max	Unit
Supply Voltage For Logic	VCC	—	3.0	3.3	3.6	V
Power Supply Voltage	V _{GH}	Ta=25°C		15		V
	V _{GL}	Ta=25°C		-10		V
Supply Current	I _{cc}	V _{CC} =3		213		mA (*NOTE1)

*Note1 : VcomH& VcomL : Adjust the color with gamma data.

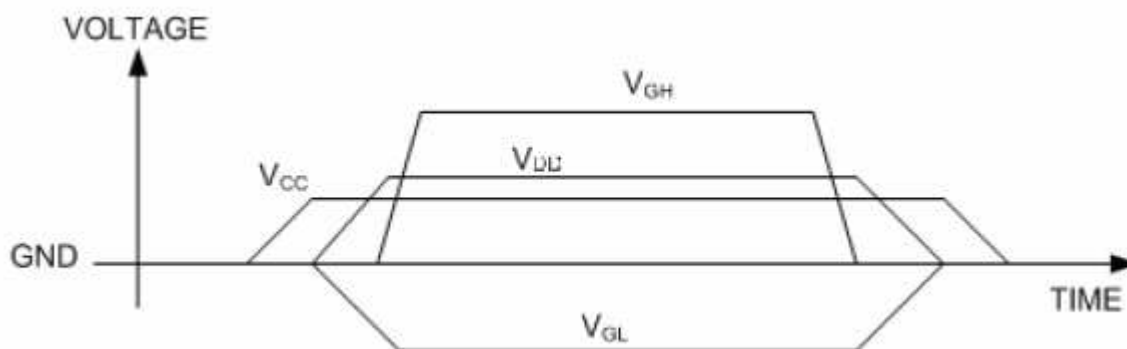

3.3 LED driving conditions

Parameter	Symbol	Min.	Typ.	Max.	Unit	Remark
LED current		-	20	-	mA	
Power Consumption		-	400	420	mW	
LED voltage	VBL+	18.6	19.8	21	V	Note 1
LED Life Time	-		(50,000)-	-	Hr	Note 2,3

Note 1 : There are 1 Groups LED

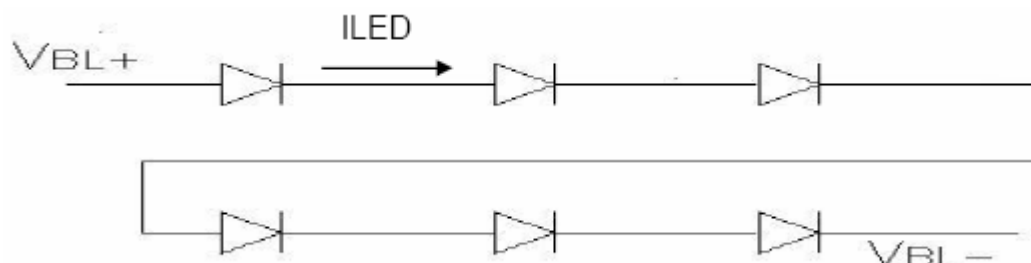

Note 2 : Ta = 25 _

Note 3 : Brightness to be decreased to 50% of the initial value

4. Absolute Maximum Ratings

Item	Symbol	Min	Typ	Max	Unit
Operating Temperature	T_{OP}	-20	—	+70	°C
Storage Temperature	T_{ST}	-30	—	+80	°C
Power Voltage	V_{GH}	-0.3	—	32.0	V
	V_{GL}	-22.0	—	0.3	V
	$V_{GH} - V_{GL}$	-0.3	—	+45	V
Input voltage	V_{in}	-0.5	—	4.6	V
Logic output Voltage	V_{OUT}	-0.5	—	4.6	V

Note: Device is subject to be damaged permanently if stresses beyond those absolute maximum ratings listed above

5.Interface Pin Function

5.1 Pins Connection To Control Board

P/N	Symbol	8BIT Function
1	GND	Ground
2	VCC	Power supply for Logic
3	BL_E	Backlight control (H: On \ L: Off)
4	RS	Command/Data select
5	WR	8080 family MPU interface : Write signal
6	RD	8080 family MPU interface: Read signal
7	DB0	Data bus
8	DB1	
9	DB2	
10	DB3	
11	DB4	
12	DB5	
13	DB6	
14	DB7	
15	CS	Chip select
16	RES	REST
17	NC	No connection
18	FGND	Frame Gnd
19	NC	No connection
20	NC	No connection

6. DC Characteristics

Conditions:

Voltage referenced to VSS

VDDD, VDDPLL = 1.2V

VDDIO, VDDLCD = 3.3V

TA = 25°C

DC Characteristics

Symbol	Parameter	Test Condition	Min	Typ	Max	Unit
PSTY	Quiescent Power			300		uW
IIZ	Input leakage current		-1		1	uA
IOZ	Output leakage current		-1		1	uA
VOH	Output high voltage		0.8VDDIO			V
VOL	Output low voltage				0.2VDDIO	V
VIH	Input high voltage		0.8VDDIO		VDDIO + 0.5	V
VIL	Input low voltage				0.2VDDIO	V

7. AC Characteristics

Conditions:

Voltage referenced to V_{SS}

V_{DD}, V_{DDPLL} = 1.2V

V_{DDIO}, V_{DDLCD} = 3.3V

T_A = 25°C

C_L = 50pF (Bus/CPU Interface)

C_L = 0pF (LCD Panel Interface)

13.1 Clock Timing

Clock Input Requirements for CLK (PLL-bypass)

Symbol	Parameter	Min	Max	Units
FCLK	Input Clock Frequency (CLK)		120	MHz
TCLK	Input Clock period (CLK)	1/fCLK		ns

Clock Input Requirements for CLK (Using PLL)

Symbol	Parameter	Min	Max	Units
FCLK	Input Clock Frequency (CLK)	2.5	50	MHz
TCLK	Input Clock period (CLK)	1/fCLK		ns

Clock Input Requirements for crystal oscillator XTAL (Using PLL)

Symbol	Parameter	Min	Max	Units
FXTAL	Input Clock Frequency	2.5	10	MHz
TXTAL	Input Clock period	1/fXTAL		ns

13.2 MCU Interface Timing

13.2.1 6800 Mode

Table 13-4: 6800 Mode Timing

Symbol	Parameter	Min	Typ	Max	Unit
t _{cy}	Reference Clock Cycle Time	9	-	-	ns
t _{PWCSL}	Pulse width CS# or E low	1	-	-	t _{CYC}
t _{PWCSH}	Pulse width CS# or E high	1	-	-	t _{CYC}
t _{FDRD}	First Data Read Delay	5	-	-	t _{CYC}
t _{AS}	Address Setup Time	1	-	-	ns
t _{AH}	Address Hold Time	1	-	-	ns
t _{DSW}	Data Setup Time	4	-	-	ns
t _{DHW}	Data Hold Time	1	-	-	ns
t _{DSR}	Data Access Time	-	-	5	ns
t _{DHR}	Output Hold time	1	-	-	ns

Figure 13-1: 6800 Mode Timing Diagram (Use CS# as Clock)

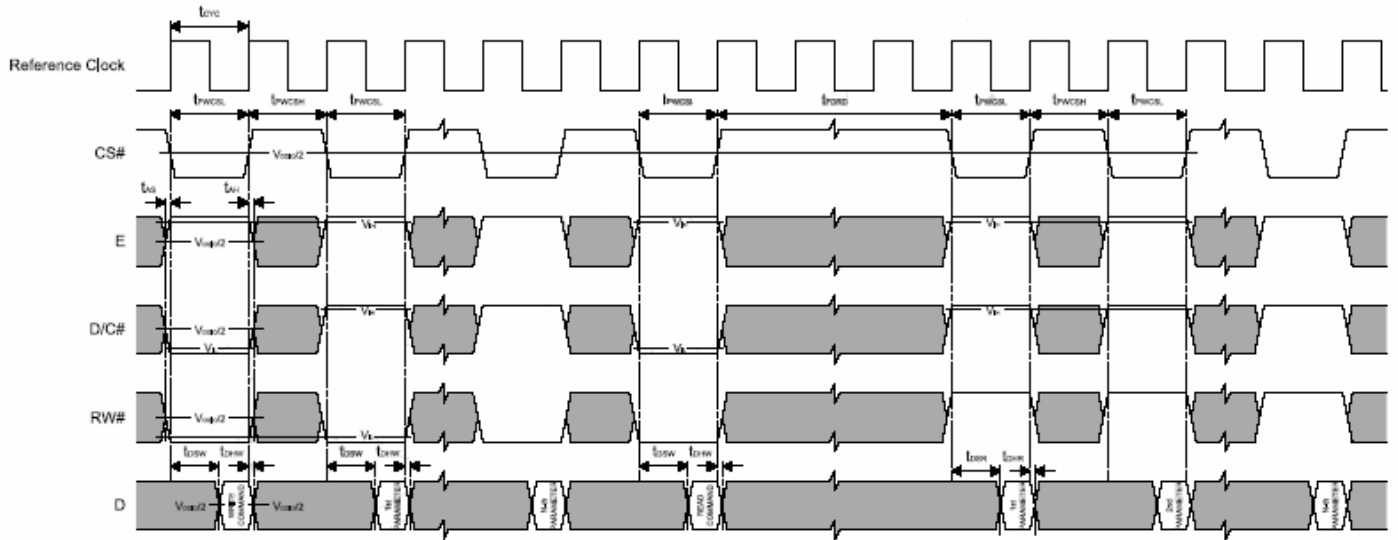
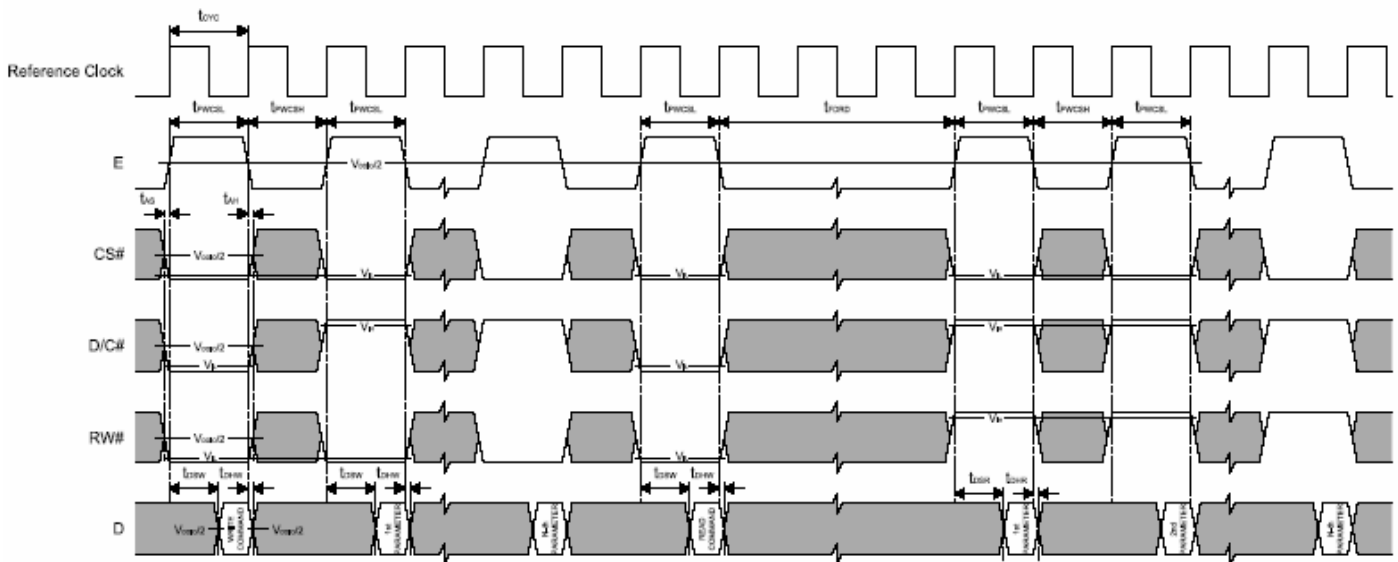

Figure 13-2: 6800 Mode Timing Diagram (Use E as Clock)



13.2.2 8080 Mode Write Cycle

Table 13-5: 8080 Mode Timing

Symbol	Parameter	Min	Typ	Max	Unit
t _{cy}	Reference Clock Cycle Time	9	-	-	ns
t _{PWCSL}	Pulse width CS# low	1	-	-	t _{CYC}
t _{PWCSH}	Pulse width CS# high	1	-	-	t _{CYC}
t _{FDRD}	First Read Data Delay	5	-	-	t _{CYC}
t _{AS}	Address Setup Time	1	-	-	ns
t _{AH}	Address Hold Time	1	-	-	ns
t _{DSW}	Data Setup Time	4	-	-	ns
t _{DHW}	Data Hold Time	1	-	-	ns
t _{DSR}	Data Access Time	-	-	5	ns
t _{DHR}	Output Hold time	1	-	-	ns

Figure 13-3: 8080 Mode Timing Diagram

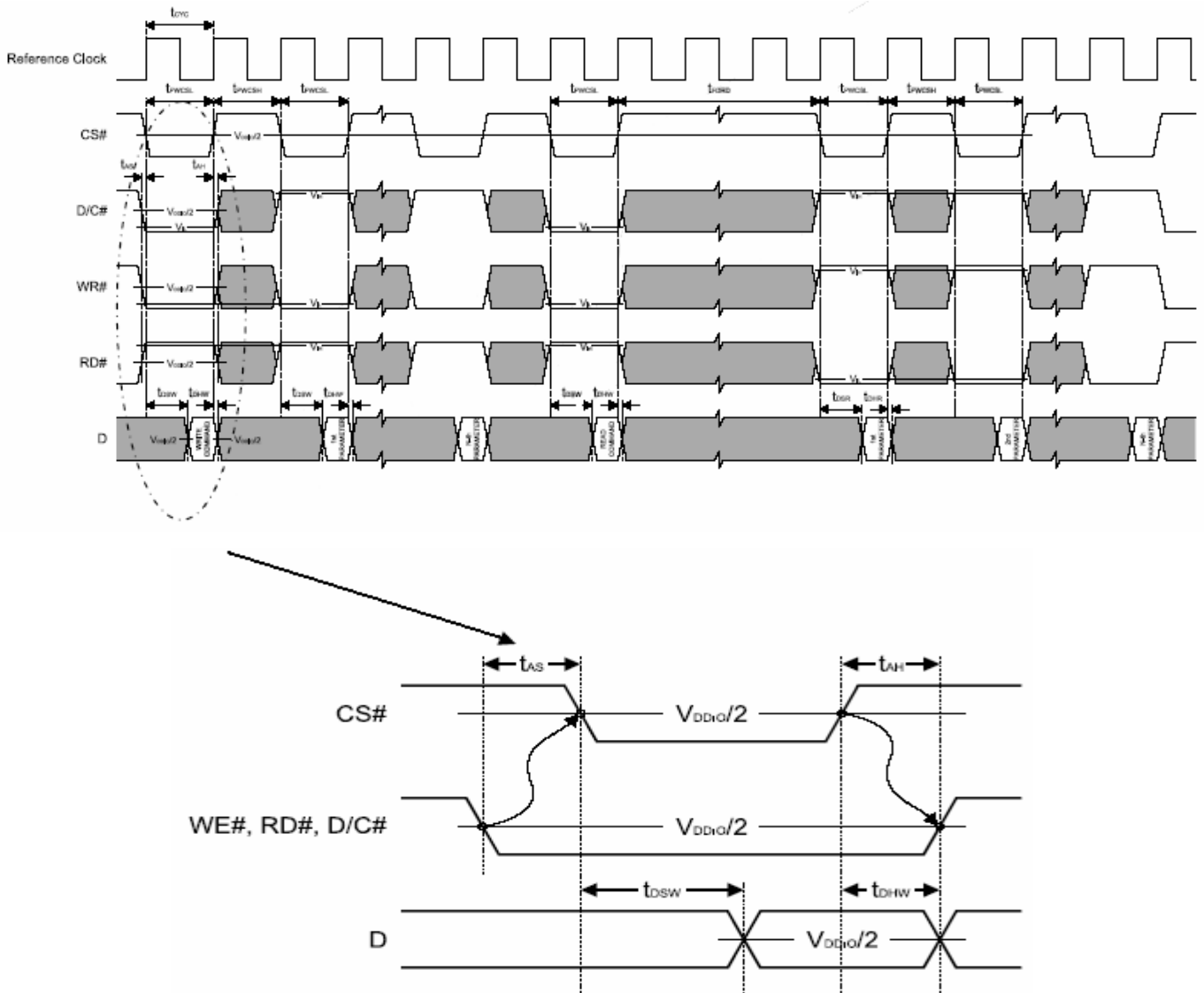

8. Data transfer order Setting

Pixel Data Format

Both 6800 and 8080 support 8-bit, 9-bit, 16-bit, 18-bit and 24-bit data bus. Depending on the width of the data bus, the display data are packed into the data bus in different ways.

Pixel Data Format :

Interface	Cycle	D[23]	D[22]	D[21]	D[20]	D[19]	D[18]	D[17]	D[16]	D[15]	D[14]	D[13]	D[12]	D[11]	D[10]	D[9]	D[8]	D[7]	D[6]	D[5]	D[4]	D[3]	D[2]	D[1]	D[0]	
24 bits	1 st	R7	R6	R5	R4	R3	R2	R1	R0	G7	G6	G5	G4	G3	G2	G1	G0	B7	B6	B5	B4	B3	B2	B1	B0	
18 bits	1 st							R5	R4	R3	R2	R1	R0	G5	G4	G3	G2	G1	G0	B5	B4	B3	B2	B1	B0	
16 bits (565 format)	1 st									R5	R4	R3	R2	R1	G5	G4	G3	G2	G1	G0	B5	B4	B3	B2	B1	
16 bits	1 st									R5	R4	R3	R2	R1	R0	X	X	G5	G4	G3	G2	G1	G0	X	X	
	2 nd									B5	B4	B3	B2	B1	B0	X	X	R5	R4	R3	R2	R1	R0	X	X	
	3 rd									G5	G4	G3	G2	G1	G0	X	X	B5	B4	B3	B2	B1	B0	X	X	
9 bits	1 st																	R5	R4	R3	R2	R1	R0	G5	G4	G3
	2 nd																	G2	G1	G0	B5	B4	B3	B2	B1	B0
8 bits	1 st																	R5	R4	R3	R2	R1	R0	X	X	
	2 nd																	G5	G4	G3	G2	G1	G0	X	X	
	3 rd																	B5	B4	B3	B2	B1	B0	X	X	

X: Don't Care

9 Register Depiction

Please consult the spec of SSD1963

10. OPTICAL CHARACTERISTIC

Ta=25±2°C, ILED=20mA

Item	Symbol	Condition	Min.	Typ.	Max.	Unit	Remark
Response time	Tr	$\theta = 0^\circ, \phi = 0^\circ$	-	10		ms	Note 3,5
	Tf		-	15		ms	
Contrast ratio	CR	At optimized viewing angle	300	400	-	-	Note 4,5
Color Chromaticity	White	Wx	$\theta = 0^\circ, \phi = 0^\circ$	(0.26)	(0.31)	(0.36)	Note 2,6,7
		Wy		(0.28)	(0.33)	(0.38)	
	Red	Rx	$\theta = 0^\circ, \phi = 0^\circ$				
		Ry					
	Green	Gx	$\theta = 0^\circ, \phi = 0^\circ$				
		Gy					
Blue	Bx	$\theta = 0^\circ, \phi = 0^\circ$					
	By						
Viewing angle	Hor.	Θ_R	CR ≥ 10	(50)	(60)	Deg.	Note 1
		Θ_L		(50)	(60)		
	Ver.	Φ_T		(40)	(50)		
		Φ_B		(45)	(55)		
Brightness	-	-	200	250	-	cd/m ²	Center of display

Ta=25±2°C, IL=20mA

Note 1: Definition of viewing angle range

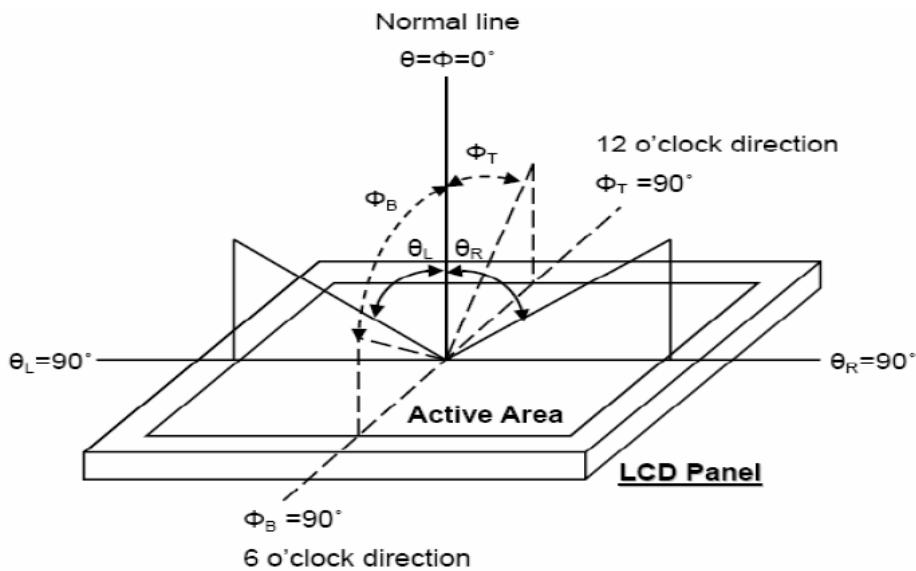

Fig. 8-1 Definition of viewing angle

Note 2: Test equipment setup:

After stabilizing and leaving the panel alone at a driven temperature for 10 minutes, the measurement should be executed. Measurement should be executed in a stable, windless, and dark room. Optical specifications are measured by Topcon BM-7 luminance meter 1.0° field of view at a distance of 50cm and normal direction.

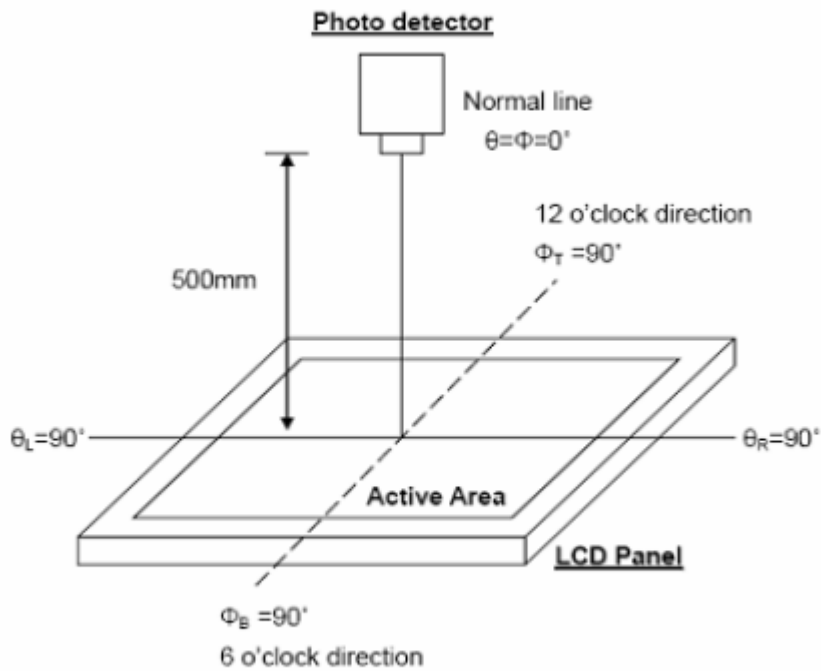

Fig. 8-2 Optical measurement system setup

Note 3: Definition of Response time:

The response time is defined as the LCD optical switching time interval between “White” state and “Black” state. Rise time, T_r , is the time between photo detector output intensity changed from 90% to 10% . And fall time, T_f , is the time between photo detector output intensity changed from 10% to 90% .

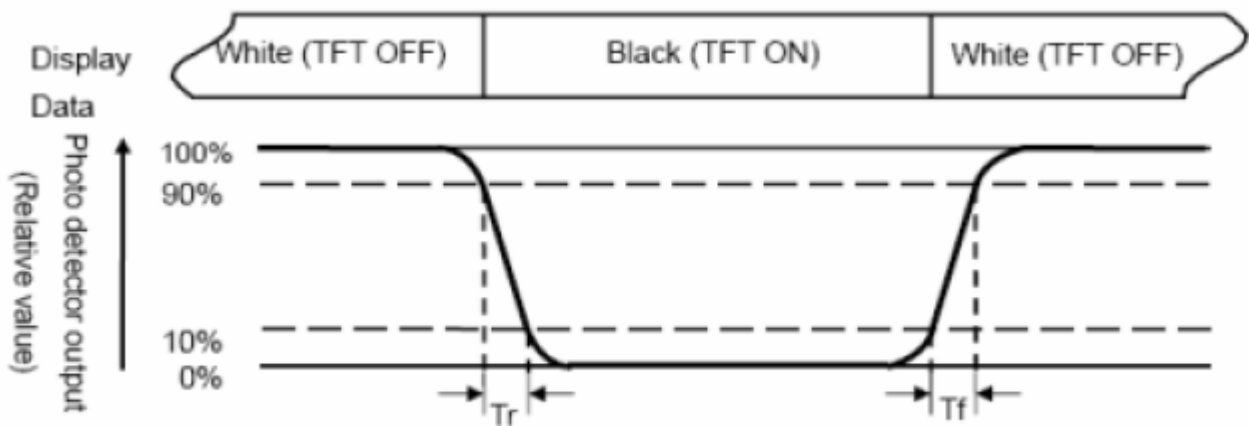

Fig. 3-3 Definition of response time

Note 4: Definition of contrast ratio:

The contrast ratio is defined as the following expression.

$$\text{Contrast ratio (CR)} = \frac{\text{Luminance measured when LCD on the "White" state}}{\text{Luminance measured when LCD on the "Black" state}}$$

Note 5: White $V_i = V_{i50} \pm 1.5V$

Black $V_i = V_{i50} \pm 2.0V$

“±” means that the analog input signal swings in phase with VCOM signal.

“±” means that the analog input signal swings out of phase with VCOM signal.

The 100% transmission is defined as the transmission of LCD panel when all the input terminals of module are electrically opened.

Note 6: Definition of color chromaticity (CIE 1931)

Color coordinates measured at the center point of LCD

Note 7: Measured at the center area of the panel when all the input terminals of LCD panel are electrically opened.

$$\text{Note 8 : Uniformity (U)} = \frac{\text{Brightness (min)}}{\text{Brightness (max)}} \times 100\%$$

11. Contour Drawing

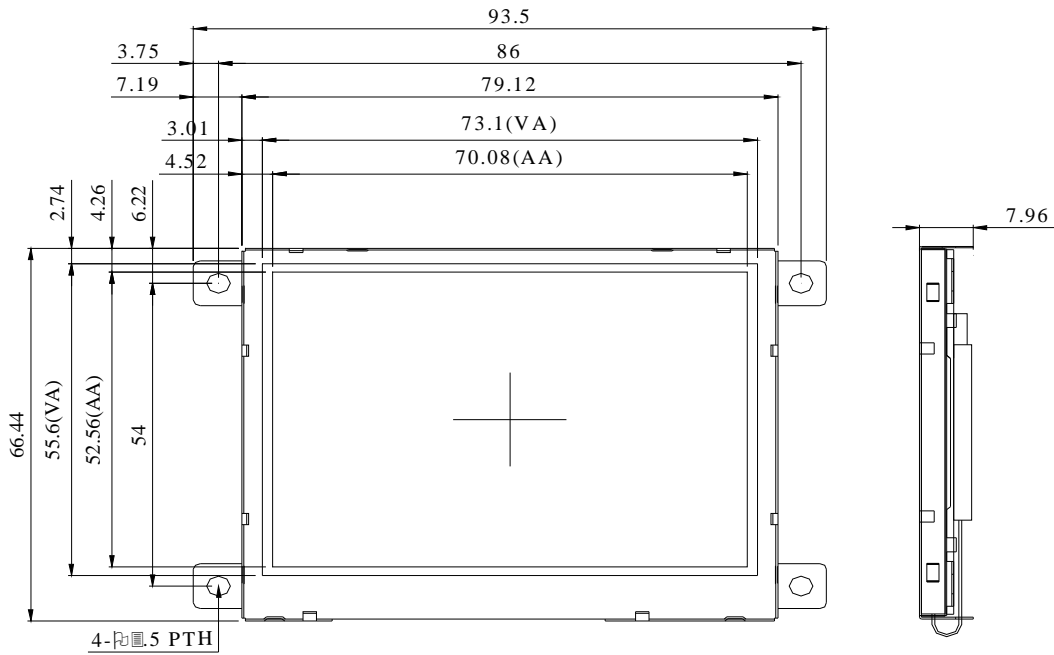

CON1	
PIN NO.	SYMBOL
1	VSS
2	VCC
3	BL_E
4	RS
5	WR
6	RD
7	DB0
8	DB1
9	DB2
10	DB3
11	DB4
12	DB5
13	DB6
14	DB7
15	CS
16	RES
17	NC
18	FGND
19	NC
20	NC

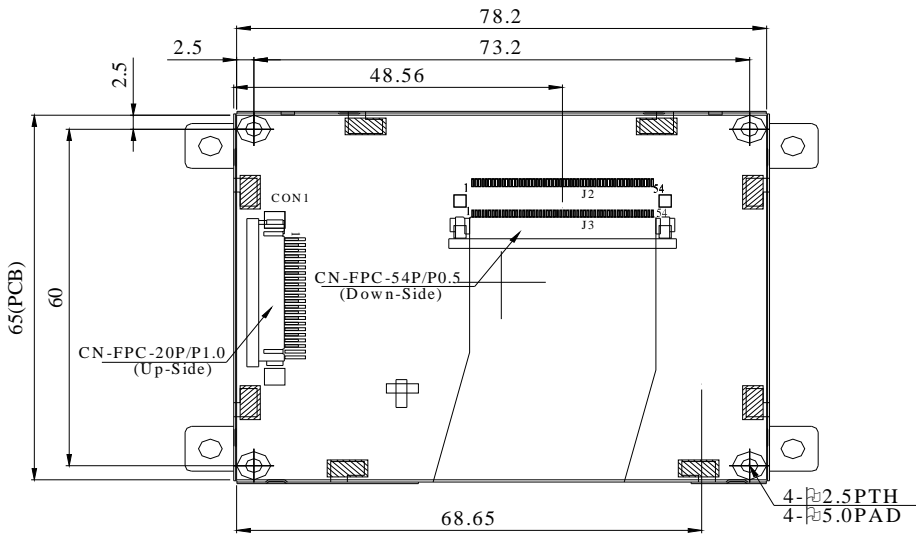

12. Reliability

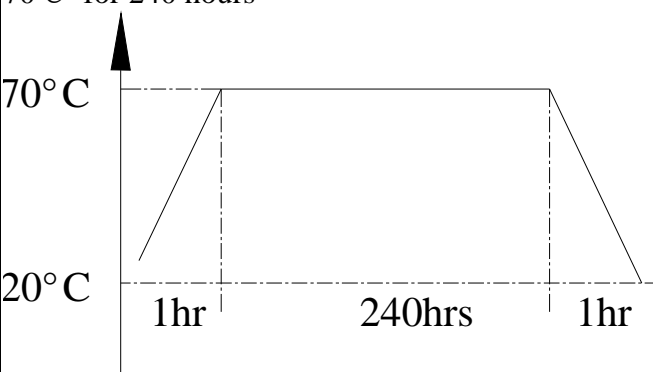
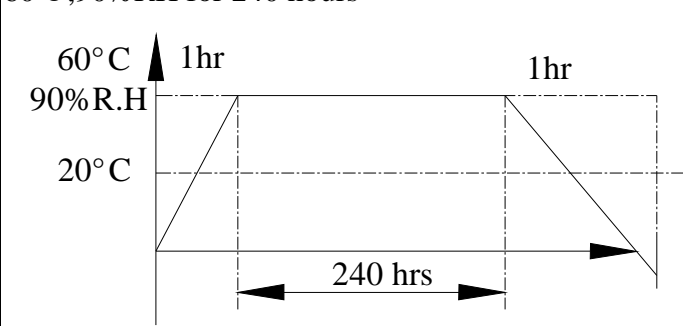
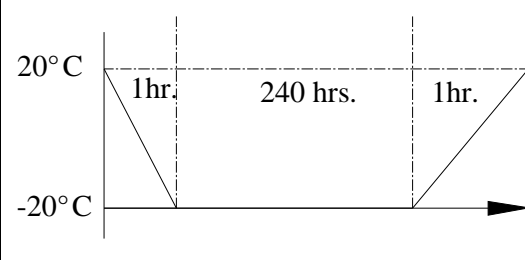
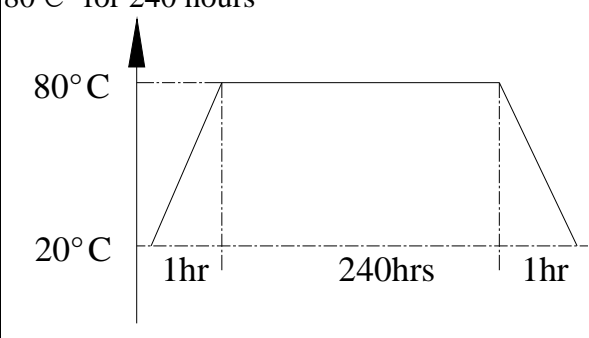
Test Item	Test Condition
High Temperature Operation	<p>70°C for 240 hours</p> 
High Temperature Operation Humidity Operation	<p>60°C, 90%RH for 240 hours</p> 
Low Temperature Operation	<p>-20°C for 240 hours</p> 
High Temperature Storage	<p>80°C for 240 hours</p> 

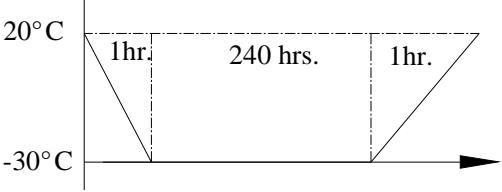
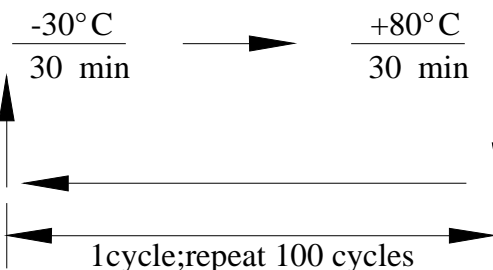
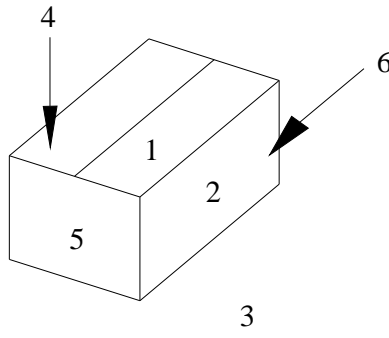
Test Item	Test Condition
Low Temperature Storage	<p>-30°C for 240 hours</p> 
Thermal Shock	<p>-30°C (30min) ~+80°C(30min) for 100 cycles</p> 
Electrostatic Discharge (Not operation)	<p>Discharge Resistance : 330 Ω Energy Storage Capacitor : 150pF Output voltage (1)Contact Discharge ±4KV (2)Air Discharge ±8KV Polarity of the output voltage : positive and negative Discharge times : 5times</p>
Package Vibration	<p>Frequency(Random Wave) • 10HZ~55HZ~10HZ Amplitude : p-p max/2.94m/s² max Orientation : X, Y , Z (3axis) Test Time : 1 hr. each axis ,total 3 hrs</p>
Package Drop Test	<p>100cm height natural falling Drop sequence : 1 corner,3 edges,and 6 faces,total 10 times</p>  <ul style="list-style-type: none"> 1)corner2-3-5 2)edge2-5 3)edge2-3 4)edge3-5 5)face5 6)face6 7)face2 8)face4 9)face3 10)face1

13. Cosmetic Criteria of LCD Screen

13.1 Inspection Condition

- Sample Plan: MIL-STD-105E LEVEL: II
AQL: Major (MA): 0.65% / Minor (MI): 1.5%
- Cosmetic inspect 300~500Lux fluorescent light, leaving 30~35cm between panels and eyes, and between panels and lights.
- Functional in spec under 200 Lux.
- Inspection condition is $23\pm 5^{\circ}\text{C}$, $50\pm 20\% \text{RH}$ maximum.

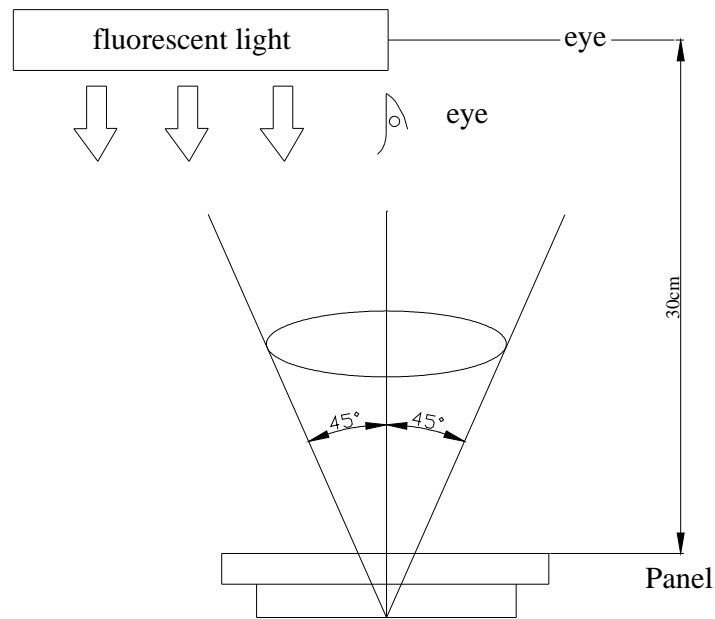

·Definition of area

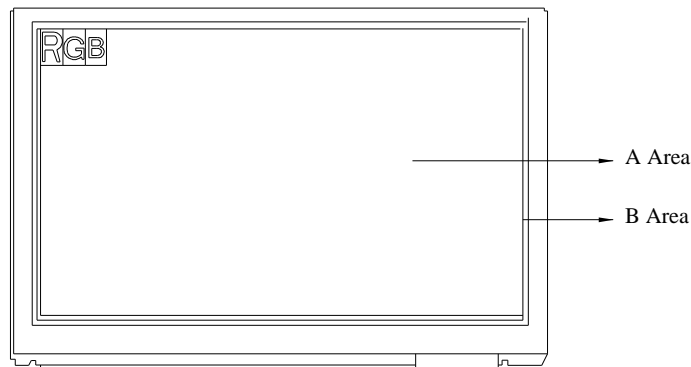

A Area: Viewing area.

B Area: Out of viewing.(Don't care cosmetic in outside viewing area)

13.2 Inspection specification

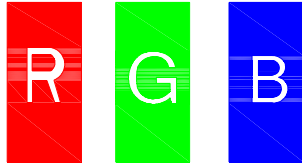
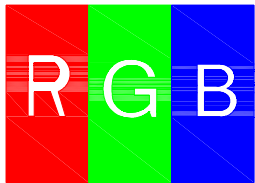
NO	Item	Acceptable specification	Judgment Criterion
1	Electrical Testing (MA)	<p>1-1 sub pixel classification</p> <ul style="list-style-type: none"> ● sub pixel: Number of sub pixel doesn't exceed Five dot. <div style="text-align: center;">  <p>Sub Pixel(Dot)</p> </div> <p>a>Dark dot ----Four Allowed b>Bright dot---one Allowed c>The definition of dot ----The size of a defective dot over 1/2 of whole dot is regarded as one defective dot. d> Dark sub pixel: The distance more than 5mm between dot and dot. e>Bright sub pixel: The distance more than 20mm between bright dot and bright dot .</p> <ul style="list-style-type: none"> ● Pixel : Three dots link together----one allowed. <div style="text-align: center;">  <p>Pixel</p> </div> <p>1-2 Leakage to light</p> <ul style="list-style-type: none"> ● Leakage to light be not allowed. <p>1-3 Picture to shake</p> <ul style="list-style-type: none"> ● Picture had shake ,twinkle and noise etc. instable of defect that be not allowed. <p>1-4 Function</p> <ul style="list-style-type: none"> ● No display or No function is not allowed. ● Source Line, Gate Line is not allowed. ● Contrast Ratio exceeds product specifications. ● Current consumption exceeds product specifications. ● Display malfunction. 	<p>N≤4 N≤1 N≤1 N=0 N=0 N=0</p>
02	Mechanical Dimension(MA)	<p>2.1 Mechanical Dimension exceeds product specifications. 2-2 Out of frame and boss of plastic changed shape that be not allowed.</p>	N=0

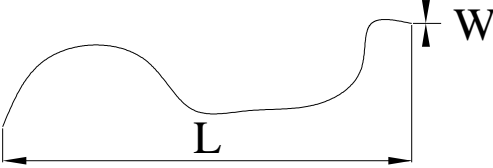
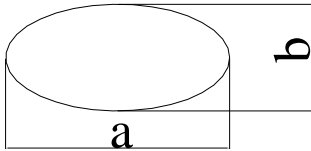
NO	Item	Acceptable specification			Judgment Criterion	
3	Cosmetic Inspection(MA)	3-1 Fiber / Line shapes of defect				
		Length	Width	Acceptable number	Mini. space	Acceptable number
		----	$W \leq 0.05$	Ignore	5mm	Ignore
		$L \leq 3$	$0.05 < W \leq 0.1$	3		3
		----	$W > 0.1$	Not allowed	---	Not allowed
		$L > 3$	----	Not allowed		Not allowed
		<p>L: length(mm) W: width(mm)</p> 				
		3-2 Blemish: dot shapes of defect.				
		Dimension		Acceptable number	Mini. space	
		$\Phi \leq 0.2$		Ignore	---	
		$0.2 < \Phi \leq 0.3$		3	5mm	
		$\Phi > 0.3$		0	----	
		3-3 Bubble				
		Dimension		Acceptable number	Mini. space	
		$\Phi \leq 0.20$		Ignore	---	
$0.2 < \Phi \leq 0.3$		3	15mm			
$\Phi > 0.3$		0	----			
Foreign Substances						
						
$\Phi = (a + b) / 2$						
		2.5				

NO	Item	Acceptable specification	Judgment Criterion																		
3	Cosmetic Inspection(MA)	<p>3-4 Scratch</p> <ul style="list-style-type: none"> ● Impassive scratch as below. <table border="1" data-bbox="517 389 1386 647"> <thead> <tr> <th data-bbox="517 389 710 472">Length</th> <th data-bbox="710 389 927 472">Width</th> <th data-bbox="927 389 1144 472">Acceptable number</th> <th data-bbox="1144 389 1386 472">Mini. space</th> </tr> </thead> <tbody> <tr> <td data-bbox="517 472 710 512">----</td> <td data-bbox="710 472 927 512">$W \leq 0.05$</td> <td data-bbox="927 472 1144 512">Ignore</td> <td data-bbox="1144 472 1386 512" rowspan="2">5mm</td> </tr> <tr> <td data-bbox="517 512 710 553">$L \leq 3$</td> <td data-bbox="710 512 927 553">$0.05 < W \leq 0.1$</td> <td data-bbox="927 512 1144 553">3</td> </tr> <tr> <td data-bbox="517 553 710 593">----</td> <td data-bbox="710 553 927 593">$W > 0.1$</td> <td data-bbox="927 553 1144 593">Not allowed</td> <td data-bbox="1144 553 1386 593" rowspan="2">---</td> </tr> <tr> <td data-bbox="517 593 710 647">$L > 3$</td> <td data-bbox="710 593 927 647">----</td> <td data-bbox="927 593 1144 647">Not allowed</td> </tr> </tbody> </table> <p>3-5 Newton Ring</p> <ul style="list-style-type: none"> ● $D \leq 8\text{mm}$----allowed ● $D \geq 8\text{mm}$----NG 	Length	Width	Acceptable number	Mini. space	----	$W \leq 0.05$	Ignore	5mm	$L \leq 3$	$0.05 < W \leq 0.1$	3	----	$W > 0.1$	Not allowed	---	$L > 3$	----	Not allowed	
Length	Width	Acceptable number	Mini. space																		
----	$W \leq 0.05$	Ignore	5mm																		
$L \leq 3$	$0.05 < W \leq 0.1$	3																			
----	$W > 0.1$	Not allowed	---																		
$L > 3$	----	Not allowed																			
4	Crack/Break(MA)	Not Allowed.	N=0																		
5	Package (MI)	<p>5-1 Mixed product types</p> <p>5-2 Shipping quantity should be the same as “shipping notice form” quantity.</p> <p>5-3 Outer box can't broken .</p>	N=0																		



Module Number : _____

Page: 1

1、Panel Specification :

- 1. Panel Type : Pass NG , _____
- 2. View Direction : Pass NG , _____
- 3. Numbers of Dots : Pass NG , _____
- 4. View Area : Pass NG , _____
- 5. Active Area : Pass NG , _____
- 6. Operating Temperature : Pass NG , _____
- 7. Storage Temperature : Pass NG , _____
- 8. Others : _____

2、Mechanical Specification :

- 1. PCB Size : Pass NG , _____
- 2. Frame Size : Pass NG , _____
- 3. Material of Frame : Pass NG , _____
- 4. Connector Position : Pass NG , _____
- 5. Fix Hole Position : Pass NG , _____
- 6. Backlight Position : Pass NG , _____
- 7. Thickness of PCB : Pass NG , _____
- 8. Height of Frame to PCB : Pass NG , _____
- 9. Height of Module : Pass NG , _____
- 10. Others : Pass NG , _____

3、Relative Hole Size :

- 1. Pitch of Connector : Pass NG , _____
- 2. Hole size of Connector : Pass NG , _____
- 3. Mounting Hole size : Pass NG , _____
- 4. Mounting Hole Type : Pass NG , _____
- 5. Others : Pass NG , _____

4、Backlight Specification :

- 1. B/L Type : Pass NG , _____
- 2. B/L Color : Pass NG , _____
- 3. B/L Driving Voltage (Reference for LED Type) : Pass NG , _____
- 4. B/L Driving Current : Pass NG , _____
- 5. Brightness of B/L : Pass NG , _____
- 6. B/L Solder Method : Pass NG , _____
- 7. Others : Pass NG , _____

>> Go to page 2 <<

5、Electronic Characteristics of Module :

- | | | |
|------------------------------|-------------------------------|-------------------------------------|
| 1. Input Voltage : | <input type="checkbox"/> Pass | <input type="checkbox"/> NG , _____ |
| 2. Supply Current : | <input type="checkbox"/> Pass | <input type="checkbox"/> NG , _____ |
| 3. Driving Voltage for LCD : | <input type="checkbox"/> Pass | <input type="checkbox"/> NG , _____ |
| 4. Contrast for LCD : | <input type="checkbox"/> Pass | <input type="checkbox"/> NG , _____ |
| 5. B/L Driving Method : | <input type="checkbox"/> Pass | <input type="checkbox"/> NG , _____ |
| 6. Negative Voltage Output : | <input type="checkbox"/> Pass | <input type="checkbox"/> NG , _____ |
| 7. Interface Function : | <input type="checkbox"/> Pass | <input type="checkbox"/> NG , _____ |
| 8. LCD Uniformity : | <input type="checkbox"/> Pass | <input type="checkbox"/> NG , _____ |
| 9. ESD test : | <input type="checkbox"/> Pass | <input type="checkbox"/> NG , _____ |
| 10. Others : | <input type="checkbox"/> Pass | <input type="checkbox"/> NG , _____ |

6、Summary :

Sales signature : _____

Customer Signature : _____

Date : ____ / ____ / ____